

# USER GUIDE

V2.1



**MODIO**  
By LogiSon  
GUESTROOM ACOUSTIC CONTROL

## Contents

|   |       |
|---|-------|
| <b>Important safety instructions</b> .....  | 2     |
| <b>About this manual</b> .....              | 2     |
| <b>Meet MODIO</b> .....                     | 3     |
| <b>What's in the MODIO Kit?</b> .....       | 3     |
| <b>What's not in the MODIO Kit?</b> .....   | 3     |
| <b>What's in the MAESTRO Pro Kit?</b> ..... | 4     |
| <b>Install MODIO</b> .....                  | 4-5   |
| Decide the location .....                   | 4-5   |
| Use the tape kit .....                      | 5     |
| <b>Connect the control pad</b> .....        | 6     |
| <b>Connect the power supply</b> .....       | 6     |
| <b>Calibrate the control pad</b> .....      | 7     |
| <b>Establish the masking spectrum</b> ..... | 7     |
| Custom tuning .....                         | 7     |
| Profile application .....                   | 7     |
| Standard spectrum .....                     | 7     |
| <b>Install MAESTRO</b> .....                | 8     |
| Prerequisites .....                         | 8     |
| Install the software .....                  | 8     |
| <b>Launch MAESTRO</b> .....                 | 8     |
| Navigate the software .....                 | 8     |
| <b>Connect MAESTRO</b> .....                | 9-10  |
| <b>Custom tune your first room</b> .....    | 11-14 |
| Create the property .....                   | 11    |
| Calibrate the sound meter .....             | 11    |
| Add the room(s) .....                       | 11-12 |
| Custom tune the room .....                  | 12-13 |
| Create a Profile .....                      | 14    |
| Set the default level .....                 | 14    |
| <b>Custom tune additional rooms</b> .....   | 14-15 |
| Tune at an existing property .....          | 14-15 |
| Tune at a new property .....                | 15    |
| <b>Adjust the level</b> .....               | 15    |
| Adjust the max level with MAESTRO .....     | 15    |
| Adjust the level with the control pad ..... | 15    |
| <b>Edit a property</b> .....                | 15    |
| Create a property .....                     | 15    |
| Edit a property file .....                  | 15    |

**Contents  
(continued)**

**Edit a room** .....16-17

- Use the room list ..... 16
- Review room details ..... 16
- Add a room ..... 16
- Edit a room..... 16
- Remove a room .....16-17
- Reset a room to factory defaults ..... 17

**Use a profile** ..... 17

- Create a profile ..... 17
- Apply a profile ..... 17
- Review a profile ..... 17
- Edit a profile..... 17

**Generate a report** ..... 18

- Select the options..... 18
- Generate a report ..... 18

**Take a measurement** .....18-19

**Educate guests** .....20

- Add MODIO to the guest directory .....20
- Provide guest instructions .....20

**Educate staff** ..... 21-23

- Restore the default level ..... 21
- Learn the basics..... 21
- Take it to the next level ..... 21-22
- Talk like a pro ..... 22-23

**Get help** .....23-24

- MODIO.....23
- Control pad.....23
- MAESTRO.....23
- Tech support .....24

**Maintenance** .....24

**Optional bracket or plate kit** ..... 25-27

- Mount under or behind furnishing .....25
- Mount to back of television.....26
- Mount to wall .....27

**MAESTRO End-User License Agreement** .....28

**Warranty** ..... 29-31

**Tech specs**.....32-33

**Mechanical drawings**.....34

## Important safety instructions

1. Read these instructions.
2. Keep these instructions.
3. Heed all warnings.
4. Follow all instructions.
5. Do not use this apparatus near water.
6. Clean only with dry cloth.
7. Do not block any ventilation openings. Install in accordance with the manufacturer's instructions.
8. Do not install near any heat sources such as radiators, heat registers, stoves, or other apparatus (including amplifiers) that produce heat.
9. Do not defeat the safety purpose of the polarized or grounding-type plug. A polarized plug has two blades, one wider than the other. A grounding type plug has two blades and a third grounding prong. The wide blade of the third prong is provided for your safety. If the provided plug does not fit into your outlet, consult an electrician for replacement of the obsolete outlet.
10. Protect the power cord from being walked on or pinched, particularly at plugs, convenience receptacles, and the point where they exit from the apparatus.
11. Only use attachments / accessories specified by the manufacturer.
12. Refer all servicing to qualified service personnel. Servicing is required when the apparatus has been damaged in any way, such as if a power-supply cord or plug is damaged, liquid has been spilled or objects have fallen into the apparatus, the apparatus has been exposed to rain or moisture, does not operate normally, or has been dropped.

---

**CAUTION:** These servicing instructions are for use by qualified service personnel only. To reduce the risk of electric shock, do not perform any servicing other than that contained in the operating instructions unless you are qualified to do so.

---

**WARNING:** To reduce the risk of fire or electric shock, do not expose this apparatus to rain or moisture. Apparatus shall not be exposed to dripping or splashing and no objects filled with liquids, such as vases, shall be placed on the apparatus.

---

## About this manual

This manual is intended for individuals installing and tuning MODIO® Guestroom Acoustic Control. It offers an overview of the kit components, required equipment installation and tuning procedures, as well as technical support and maintenance information. It also provides best practices and operational instructions to ensure both the property and its guests get the most from this technology.

**IMPORTANT:** K.R. Moeller Associates Ltd. (the 'MODIO manufacturer') does not assume any responsibility or liability for the information given and shall not be liable for any direct, indirect, special, incidental or consequential damages in connection with the use of this information. The information in this manual is subject to change without notice.

## Meet MODIO

MODIO introduces a continuous soothing masking sound into the room, allowing guests to control its acoustical ambience as they would temperature and lighting. The sound is similar to soft airflow, designed for comfort, and engineered to cover a variety of hotel noises.

MODIO is quick and easy to install. Several options are available, but the most common location is beneath or behind a furnishing—such as a desk, table or cabinet—or behind a freestanding television. Custom tuning with MAESTRO software achieves the optimal masking effect within the room.

Much like a dimmer switch, a control pad allows each guest to set the masking sound level according to their personal preference or as needed to cover disturbances.

---

### What's in the MODIO Kit?

- MODIO
- Control Pad
- Power Supply
- Power Coupler
- Tape Kit
- Information Card

For more information about these components, see the 'Tech Specs' and 'Mechanical Drawings' sections of this manual.

---

### What's not in the MODIO Kit?

#### Optional bracket or plate

The tape kit (included) contains three long pieces of highly-adhesive, double-sided tape for MODIO and one short piece for the control pad, as well as two alcohol wipes. Alternatively, you can mount MODIO using a bracket or a plate kit (optional), which are available for separate order from the MODIO manufacturer:

- *Bracket kit* – Used to mount MODIO to a furnishing or the back of most freestanding televisions using the VESA mounts. This kit includes two brackets, six rectangular washers and four 3/8-inch 8-32 flathead bolts.
- *Plate kit* – Used to mount MODIO to a wall or to the back of a small freestanding television using the VESA mounts. This kit includes a mounting plate and two 3/8-inch 8-32 flathead bolts.

To determine the mounting solution that will work best for your application, review the 'Install MODIO' and 'Optional Bracket or Plate Kit' sections of this manual. If mounting MODIO to the back of a freestanding television, first verify its VESA hole pattern and dimensions (e.g., 100 mm, 200 mm, 200-400 mm).

#### Additional equipment

##### *If using the tape kit, you also need:*

- Cable ties, to secure the cables and keep them tidy

##### *If using the bracket or plate kit, you also need:*

- A Phillips screwdriver, to tighten the supplied bolts
- An adjustable wrench or 11/32-inch hex wrench, if the VESA mount is 400 mm or larger
- Screws, if attaching MODIO to a furnishing
- Screws and anchors, if attaching MODIO to a wall

##### *If installing MODIO in a region that does not use North-American style NEMA 1-15P electrical outlets, you also need:*

- A power cord(s) that conforms to the local power outlet, to connect to the power supply

##### *If placing the control pad more than 1.8 m (6 ft) away from MODIO, you also need:*

- A 3.5 mm 4-pole headphone extension cable

## What's in the MAESTRO Pro Kit?

To custom tune MODIO or take sound level measurements, you need a MAESTRO Pro Kit (sold separately), which includes:

- Sound Meter
- Calibrator & Adapter
- MODIO Adapter
- Cable & Coupler
- USB Cable & Splitter
- Power Supply
- Screwdriver
- Document Sleeve

You also require MAESTRO 2.0 (or later) and a laptop equipped with Microsoft Windows.

## Install MODIO

One MODIO covers a typical single guest room. In a multi-room suite, you may need to install more than one device; for example, one MODIO in the bedroom and another in the living area.

**IMPORTANT:** The MODIO manufacturer recommends using UL-listed or equivalent materials during installation. All installation methods must comply with all locally-applicable building code requirements.

### Decide the location

MODIO can be installed in a variety of locations. In order of (acoustical) preference, and depending on the design/layout of each room, these include:

- Beneath or behind a furnishing, such as a table, desk or cabinet
- Behind a freestanding television
- On the wall, above a wall-mounted television
- On top of a cabinet
- Beneath a bed
- Beneath a bedside table
- Other locations, as possible or required

When deciding the location, keep in mind that it will affect the device's visibility, access to power, placement of the control pad, and guests' experience of the sound. If possible, it is preferable to install MODIO across the room from the bed, rather than next to it.

Also keep in mind that:

- Performance is based on the level of the masking sound 'at your ear,' not the location of the device. In other words, positioning MODIO between you and a noise source will not improve performance.
- The masking sound level changes depending on your proximity to MODIO.
- The minimum space recommended for installation behind furnishings is 15 cm (6 inches). Tighter spacing can work, providing custom tuning achieves the required curve.
- In a room with a wall-mounted television, you can install MODIO just above the television, allowing the cables to run down behind it. Plug the power cable into the electrical outlet and place the control pad on a furnishing beneath the television.

## Install MODIO (continued)

### IMPORTANT:

- You are responsible for the mounting location. Avoid locations where a falling device could cause damage or injury. The MODIO manufacturer is not responsible for your choice of location.
- Maintain a distance of at least 60 cm (24 inches) between the guest's ear and the device, particularly if the maximum output level exceeds 60 decibels.
- If installing behind a television, ensure MODIO does not substantially block the television's ventilation. If so, use a different installation option.
- If using the tape kit, ensure the mounting surface is flat. Curved surfaces may result in the device falling.
- The tape is highly adhesive. Improper removal may damage the mounting surface. The MODIO manufacturer is not responsible for such damage. For removal instructions, contact the manufacturer by chat, phone or email by visiting [3m.com](https://www.3m.com) and clicking on 'Help Center' at the bottom of the homepage. Reference the 3M part number: RP62.

### Use the tape kit

**NOTE:** If using the optional bracket or plate kit (e.g., when mounting MODIO to a wall or to the back of a television using its VESA mounts), see the related section at the end of this manual.

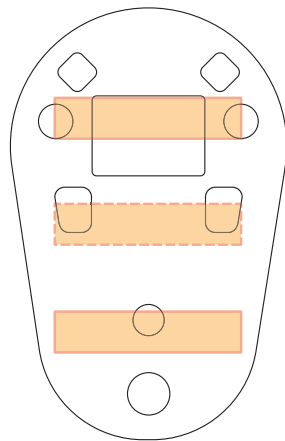

1. Determine the installation location.
2. Place MODIO grill side down on a soft surface.
3. Use an alcohol wipe to clean the back of the device and the mounting surface.

**NOTE:** Ensure both surfaces are dry, prior to applying the tape.

4. Remove the liner from one side of the tape.

**IMPORTANT:** Handle tape by edges only.

5. Attach at least two pieces of the supplied tape to MODIO, per the diagram above and following the instructions in steps 5 and 6 below. The third (middle) piece is optional.

6. Remove the liner from the other side of the tape.

7. Place MODIO in the desired position and apply firm pressure for at least 45 seconds.

**NOTE:** Full bond strength is achieved after 72 hours.

### Connect the control pad

The control pad has a standard 1.8 m (6 foot) cable. If a longer distance is required between MODIO and the control pad, purchase a 3.5 mm 4-pole headphone cable extender.

1. Insert the plug at the end of the control pad cable into the jack on MODIO.
2. Place the control pad in a suitable location.

**NOTE:** The control pad does not need to be within reach from the bed.

### Connect the power supply

The MODIO Kit includes one of two power supply models: either Model SW118-24-N, which is intended for use in North America and other regions using NEMA 1-15P electrical outlets, or Model GST25A24, which is intended for use in regions featuring other types of electrical outlets. If using GST25A24, purchase a power cord that conforms to the local power outlet.

1. Insert the power coupler into the 6-pin connector on MODIO, ensuring the locking mechanism (i.e., the small tab below the six pins) goes into the rectangular slot.

**NOTE:** To remove the power coupler, use a small screwdriver to press the locking mechanism against the coupler and pull the coupler out. Attempting to remove the coupler without releasing the locking mechanism will damage the device.

2. Insert the barrel plug at the end of the power supply cord into the power coupler

**NOTE:** If you purchased a power cord with a non-North American plug, connect it to the power supply.

3. Plug the power supply into an appropriate electrical outlet.

**NOTE:** When powering up following connection of the power supply or after a power failure, MODIO gradually ramps up the masking level in order to maintain guest comfort.

## Calibrate the control pad

To calibrate the control pad:



1. Disconnect power.



2. Turn the dial to MAX.



3. Reconnect power.



4. Within two (2) seconds, turn the dial to OFF. MODIO beeps once.



5. Within two (2) seconds, turn the dial to MAX. MODIO beeps twice, confirming dial calibration.

Once calibrated, you can turn the masking off by turning the dial below a setting of '1' or fully 'OFF.' From that point, turning the dial clockwise turns the masking sound on and steadily increases the level in incremental, clicked steps up to '10.'

## Establish the masking spectrum

The goal of guestroom sound masking is to ensure the highest level of acoustical performance and consistent guest experience in every room. To achieve the most effective masking sound, while bearing in mind the need for efficient setup, MODIO offers three options:

### Custom tuning

The masking sound is affected by the room's dimensions, finishes and furnishings, as well as by the location MODIO is installed; therefore, the MODIO manufacturer recommends using MODIO MAESTRO 2.0 (or later) and the MAESTRO Pro Kit to custom tune the masking sound within each room. This software controls the sound's frequencies and overall level in a precise manner, ensuring it meets the target masking spectrum or "curve." The default spectrum is one the National Research Council's (NRC) research shows best balances masking performance with occupant comfort; however, you can also tune to another spectrum, if specified (e.g., by an acoustician).

If using MAESTRO for the first time, see 'Install MAESTRO,' 'Launch MAESTRO,' 'Connect MAESTRO,' and 'Custom tune your first room.'

### Profile application

Although tuning each guest room is the gold standard, it is not always feasible (e.g., due to persistent interfering noise in the room). If you use MAESTRO to custom tune a room, you can save its settings as a Profile and apply them to another room of the same type (i.e., one with the same dimensions, finishes, furnishings, and MODIO location).

### Standard spectrum

If neither of the above options is feasible, MODIO offers a pre-set spectrum designed for use when the device is installed on top of a furnishing.

## Install MAESTRO

### Prerequisites

MAESTRO runs on platforms supporting the .NET Framework 4.8, which are currently Windows 10 May 2019 Update (Version 1903) or later. The .NET Framework is included in Windows 10 updates, as well as with Windows 11, and also offered as a free download from the Microsoft Download Center website.

### Install the software

**IMPORTANT:** See the *MAESTRO End-User License Agreement* in this guide. You may require the administrator password for your laptop to complete this procedure.

**NOTE:** Download MAESTRO, if required. If the software is compressed into a zip file, extract the contents into a temporary location.

1. Open 'File Explorer' and navigate to the installation files.
2. Double-click 'setup.exe.'
3. Follow the on-screen instructions.

## Launch MAESTRO

To launch the software, go to the Start button > All Apps > MODIO folder and click the MODIO MAESTRO V2.0 shortcut or double-click the MAESTRO desktop shortcut.

If you will use the software regularly, you can pin the shortcut to the Windows taskbar.

### Navigate the software

MAESTRO always opens on the Property screen.

Click the menu button  to access other functions, including:

- *Property*  
Allows you to create and manage property files, which store information about each property and the MODIO devices installed there, as well as measurements and settings.
- *Rooms*  
Allows you to create and manage the property's rooms and also offers a range of functions related to the MODIO devices installed there. This screen also offers tuning and measurement functions.
- *Profiles*  
Allows you to manage the profiles you create.
- *Reports*  
Allows you to run detailed reports about tuning and settings.
- *Setup*  
Allows you to select (if not autodetected) and calibrate your sound meter (if BSWA), restore MODIO factory defaults, replace a control pad or change its type (if replaced). You can also check details pertaining to the sound meter and currently connected MODIO, and copy settings to a document or email.
- *Help*  
Allows you to access the user guide.
- *About*  
Tells you the software version and allows you to check for updates.

**NOTE:** Some functions may be disabled based on connected devices and data entered. For example, when the laptop is not connected to MODIO, the 'Reset' and 'Max Volume' buttons are disabled on the Rooms screen.

## Connect MAESTRO

**NOTE:** MAESTRO Pro Kit and internet connection required.

Before beginning this procedure, ensure the power supply (if applicable) is unplugged and the power coupler is not connected to MODIO. To remove the power coupler, use a small screwdriver to press the locking mechanism against the coupler and pull the coupler out. Attempting to remove the coupler without releasing the locking mechanism will damage the device.

Both the sound meter and MODIO adapter connect to the laptop using a USB-A cable. If your laptop only offers one USB-A connection, use the splitter (supplied). If your laptop has no USB-A connection, you will need a USB-C to USB-A converter (not supplied).

**IMPORTANT:** The sound meter has been pre-configured at the factory. If you accidentally change the settings and need to reset them, or require a firmware upgrade, contact MODIO Tech Support. See 'Get help.'

1. Launch MAESTRO.

**NOTE:** The software checks if the drivers required for the sound meter and MODIO adapter are already installed and, if not, displays the Equipment Setup window. Follow the onscreen instructions. Note that you will connect the sound meter and MODIO adapter to the laptop as part of this process and can skip step 3 and 4 c) below.

2. Go to the software's Setup screen.

3. Connect the sound meter to the laptop (USB-A).

**NOTE:** When connected to the laptop, the BSWA sound meter does not need batteries to operate.

4. Referring to the diagram on the next page, connect the:

- a) Cable (A) to MODIO and to the coupler (B).

- b) Coupler to the MODIO adapter (C).

- c) MODIO adapter to your laptop's second USB-A connection (D) or to the splitter.

- d) MODIO adapter to the power supply (E).

5. Plug the power supply in and power up the sound level meter.

**NOTE:** Also ensure the control pad is connected to MODIO.

**NOTE:** Once you complete the tuning process, disconnect all of the equipment except the control pad. Use the power coupler to connect the power supply to MODIO and plug the power supply in. See 'Connect the power supply.'

## Connect MAESTRO (continued)

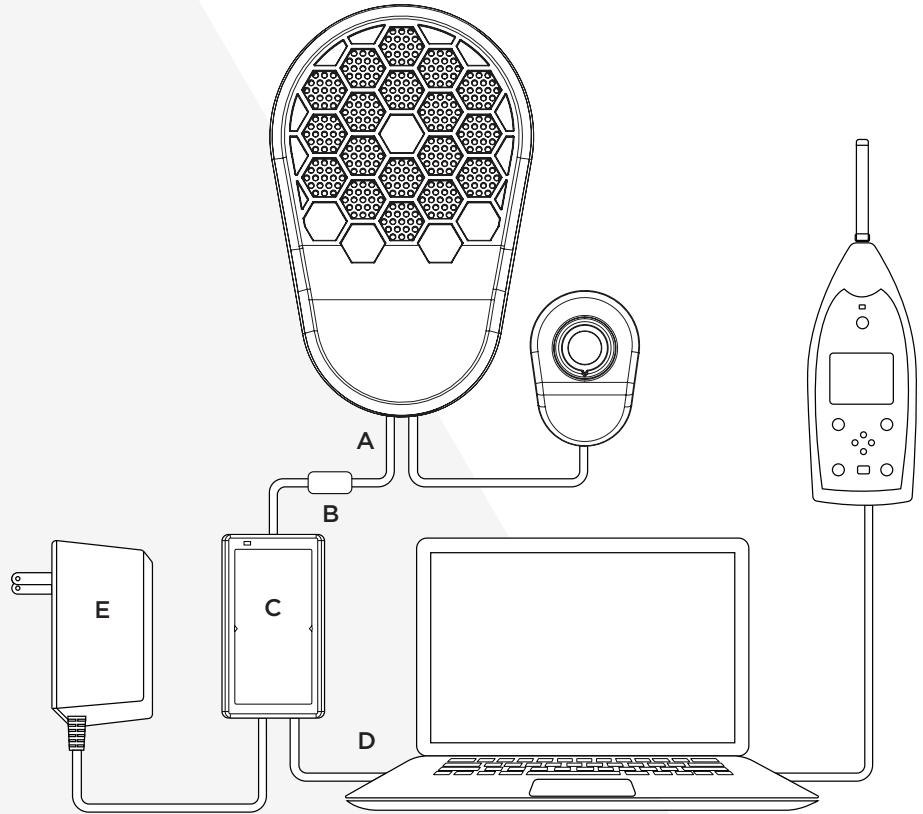

MAESTRO displays each item's connection status at the bottom of the Setup screen. If you have properly connected all items, MAESTRO displays three green checkmarks.



If you have not connected an item correctly or MAESTRO is unable to communicate with it, MAESTRO displays a red X next to it and offers a 'Help' link, which you can click to begin the troubleshooting process. Simply follow the onscreen steps. If you resolve the issue, MAESTRO replaces the X with a checkmark after a few seconds. If you cannot resolve the issue, contact MODIO Tech Support. See 'Get help.'



**IMPORTANT:** From time to time, a connection might drop. Such interruptions are normal, and MAESTRO should restore the checkmark after a few seconds.

## Custom tune your first room

This section describes the process of custom tuning your first room and ensures you are familiar with all of the details involved in the process. When tuning subsequent rooms, refer to 'Custom tune additional rooms.'

**IMPORTANT:** Prior to beginning this procedure, ensure MAESTRO is installed, all of the required equipment is connected and powered up.

### Create the property

1. Click the 'New' button. MAESTRO displays the Property window.
2. Enter the property name (and add more details, if desired for reports).
3. To save the file, click the 'OK' button. MAESTRO saves it to the Documents/MODIO/MAESTRO/Properties folder using an .mdio extension.

**IMPORTANT:** Save a backup in your organization's preferred location.

**NOTE:** If you have multiple properties, create a separate file for each location. You can also handle this task at a later date.

### Calibrate the sound meter

MAESTRO should autodetect the sound meter you are using, providing the meter is connected and powered up; however, if it does not, you can either select your meter from the dropdown list at the top of the Setup screen or click the 'Detect' button.

**IMPORTANT:** You MUST calibrate the sound meter prior to tuning (e.g., at the beginning of each day you plan to use the meter). Uncalibrated meters can result in incorrect adjustment of MODIO.

If using a BSWA sound meter, you can calibrate it within MAESTRO.

1. Go to the Setup screen.
2. Click the 'Calibrate' button.
3. Follow the onscreen instructions.

If using another sound meter model, contact MODIO Tech Support. See 'Get help.'

**NOTE:** MAESTRO will ensure all sound meter settings are appropriate for measurement and tuning. You do not need to use the meter's interface.

### Add the room(s)

Create a record for each room in which you intend to install MODIO. You can do so individually as you move from room to room or create multiple rooms simultaneously as described in step 3 below.

1. Go to the Rooms screen.
2. Click the '+' button.
3. Enter the floor and room number or name. MAESTRO displays the room(s) in the preview window and flags any duplicate entries with an info icon.

**NOTE:** Room numbers can be alphanumeric (i.e., use numbers and/or letters). You can also enter symbols, providing they are not hyphens.

**NOTE:** To create multiple rooms, enter a numeric range separated by a hyphen (e.g., 101-111) or, if the room numbers are non-sequential, separated by a comma (e.g., 112, 115, 121). You can also combine sequential and non-sequential room numbers (e.g., 101, 103, 110-115).

**NOTE:** MAESTRO will not create records for duplicate entries.

## Custom tune your first room (continued)

4. Enter any notes into the 'Notes' field, if desired.  
**NOTE:** If you created multiple rooms simultaneously, MAESTRO applies the notes to all of the rooms.
5. To complete the process, click the 'Add' button.
6. If you have added all of the required rooms, click the 'Close' button.  
**NOTE:** MAESTRO displays the rooms in a list, grouped by floor. New rooms have a 'Pending Setup' status until you custom tune or apply a Profile to the MODIO devices installed within them.

### Custom tune the room

**NOTE:** If uninterrupted, this process takes approximately 90 seconds.

1. On the Rooms screen, select the room you are in.
2. Click the  icon. MAESTRO displays the Customize window.
3. Select the target spectrum and max level or accept the defaults.  
**NOTE:** You will typically use the factory defaults (i.e., the NRC's Optimal Masking Spectrum and a max level of 48 dBA).  
**NOTE:** To import a different spectrum, click the 'Import' button, which defaults to your Documents folder. Navigate to the desired .tcrx file provided by MODIO Tech Support and click the 'Open' button. If you close and reopen the software, it will have restored the Customize window to the factory defaults.  
**NOTE:** During the tuning process, you establish the maximum masking sound level (i.e., max level) achieved with the control pad dial at '10.' The default of 48 decibels typically covers most noise and also satisfies guest preferences. It results in a level of approximately 26 decibels at the lowest setting on the dial, which approximates that of the existing background sound level in most guest rooms and, hence, is unnoticeable to most occupants (there is also an 'OFF' setting). If MODIO is intended to address a particularly high level of noise, you might set the max level 1 to 3 dBA higher. If needed, you can also adjust it later without retuning; see 'Adjust the level.'  
**NOTE:** When not tuning, MAESTRO displays a lock icon indicating the control pad is enabled. During tuning, MAESTRO automatically unlocks MODIO, which disables the control pad and sets the masking sound to the max level to ensure you are tuning at that level.  
**NOTE:** If you change the settings and would like to restore the target spectrum and max level to the factory defaults, click the 'Reset' button.  
**NOTE:** MAESTRO measures and tunes from 63 to 10,000 Hz, but only reports errors encountered within the target range of 100 to 5,000 Hz.
4. If using MODIO to address very low frequency noise (e.g., bass in music, train or aircraft traffic), enable the 'Bass Boost' option. During tuning, MAESTRO will increase low frequency output while maintaining the desired spectrum.
5. Select the tuning location for the room.  
**NOTE:** To ensure optimal masking for sleep, stand beside the head of the bed during tuning.  
**NOTE:** If MODIO is intended to improve the acoustics in another area of the guest room or another space within the hotel, select a location in the primary area of concern and stand there during tuning.

**Custom tune  
your first  
room  
(continued)**

6. Click the 'Customize' button. MAESTRO provides a 3-second countdown before beginning the tuning process.

**IMPORTANT:** The sound meter is very sensitive, so it is essential to remain as silent as possible during tuning. While MAESTRO is engineered to accommodate a degree of unexpected noise, significant and/or extended noise(s) can lengthen tuning time or prevent it altogether.

**NOTE:** If MODIO is already assigned to a room other than the one for which you are attempting to tune, MAESTRO displays a warning. To tune MODIO for this new room, click the 'Yes' button. Otherwise, click the 'No' button to stop the tuning process.

7. Hold the sound meter in front of you, with its microphone facing upwards (between 45 degrees and vertical), and approximately 4 ft (1.2 m) from the floor. Move the meter from side to side, in a 2-foot (60 cm) arc. Each pass should take approximately 1 second; moving too quickly can affect measurement due to 'airflow' noise at the microphone tip. Keep moving in this manner throughout the tuning process.

MAESTRO automatically progresses through the following five steps. The software typically accomplishes them in order, without interruption; however, if an issue arises, MAESTRO may return to an earlier step in an attempt to resolve it or offer you options about how to proceed.

*Step 1 - Checking Background Sound Levels*

If MAESTRO detects background sound levels that would interfere with tuning, it prompts you to retry or cancel the process. You can view a graph of the background measurement to see what frequencies are too near – or above – the target masking spectrum. If possible, address the noise source(s) before clicking the 'Retry' button.

If MAESTRO still detects interfering noise, it offers the option of applying a Profile. If you have already created a Profile for the current room type within the property and the interfering noise is beyond your ability to control, you can accept this option. Alternatively, you can cancel the process and attempt to tune at another time (e.g., when exterior traffic is calmer or housekeeping staff are not working nearby).

*Step 2 - Initial Measurement and Adjustments*

MAESTRO makes up to five two-second tests.

*Step 3 - Checking Volume*

MAESTRO checks the volume setting to ensure all frequency levels are attainable. If changes are required, MAESTRO makes secondary adjustments. If MAESTRO detects noise during this step, it attempts further adjustment before indicating a problem.

*Step 4 - Precision Adjustments*

MAESTRO uses longer tests – starting at five seconds and increasing to ten – to make fine adjustments, during which time the software also makes a secondary volume check. If secondary adjustments are required, MAESTRO makes them. If MAESTRO detects noise during this step, it repeats the measurement. After three unsuccessful attempts, MAESTRO prompts you to retry or cancel the process.

*Step 5 - Final Verification*

MAESTRO takes a final 15-second measurement. If tuning is within target, it displays a congratulatory message and graph of the results. If tuning is outside target, it displays a failure message and asks if you want to retry, apply a Profile, or cancel the process.

## Custom tune your first room (continued)

### Create a Profile

If desired, you can save the settings in a Profile so that you can later apply them to another room of the same type.

**NOTE:** For more information about profiles, see 'Use a Profile.'

1. Click the  icon.
2. Enter the desired name for the Profile.

### Set the default level



**NOTE:** This is the number to which housekeeping staff will set the control pad dial after a guest departs. See 'Educate staff.'

Now that you have completed the tuning process, the control pad is automatically enabled and you can set it to your property's desired default masking setting, which depends on your preference, as well as the level of unwanted noise typically affecting guestroom occupants. It is also related to the max level (i.e., achieved when the control pad is set to '10') established during the tuning process; for example, if you tuned MODIO to 48 decibels at the bed and set the dial to a default level of '4,' the level will be 8 decibels lower (i.e., 40 decibels), as shown in the diagram in 'Adjusting the level with the control pad' below. If unsure, a default of 40 decibels is a good place to begin. You can change it at a later date, based on guest feedback or general noise levels at your property (e.g. seasonally).

## Custom tune additional rooms

**IMPORTANT:** The following procedures assume MAESTRO is installed and launched, the required equipment is successfully connected and powered up, and you are familiar with the detailed instructions provided in 'Custom tune your first room.'

### Tune at an existing property

1. Open the existing property file.
2. If you have not calibrated your BSWA sound meter:
  - a) Go to the Setup screen.
  - b) Click the 'Calibrate' button.
  - c) Follow the onscreen instructions.
3. If you have not created the room:
  - a) Go to the Rooms screen.
  - b) Click the '+' button.
  - c) Enter the floor and room number or name.
  - d) Enter any desired notes into the 'Notes' field.
  - e) To complete the process, click the 'Add' button.
  - f) Click the 'Close' button.
4. On the Rooms screen, select the room you are in.
5. Click the  icon.
6. Accept the factory defaults or import a different spectrum and/or adjust the max level.
7. Enable the 'Bass Boost' option, if required.
8. Stand in the tuning location (e.g., at the head of the bed).
9. Hold and move the sound meter in the required manner.
10. If issues arise, respond to the MAESTRO prompts as required.
11. If desired, save the settings in a Profile:
  - a) Click the  icon.
  - b) Enter the desired name.

12. Set the default masking level on the control pad.

### Tune at a new property

After creating the property file, follow the steps outlined above.

## Adjust the level

### Adjust the max level with MAESTRO

During the tuning process, you established the maximum masking sound level achieved with the control pad dial at '10.' If you find you need to increase the max level available to guests, you can adjust it without retuning.

1. Go to the Rooms screen.
2. To decrease the max level, click the  icon. To increase it, click the  icon. Each click adjusts the volume by 0.5 dBA.

**NOTE:** To display the current max level, mouse over the icons.

**NOTE:** If you modify the max level, MAESTRO displays an info icon next to the MODIO Max Level and Volume Setting values in the Room Detail window. For a summary of the change made since custom tuning or applying a Profile, mouse over this icon.

### Adjust the level with the control pad

The control pad offers the guest volume adjustment from 'OFF' up to '10.' To increase the volume, turn the dial clockwise. To decrease it, turn the dial counterclockwise.

The diagram below shows the approximate change *from the maximum level* at each dial setting. The increments by which the masking sound level increases gradually get smaller as the dial is turned towards '10,' giving the guest the finer control required at the upper end of the volume range. The overall range between the lowest and maximum setting is approximately 22 decibels.

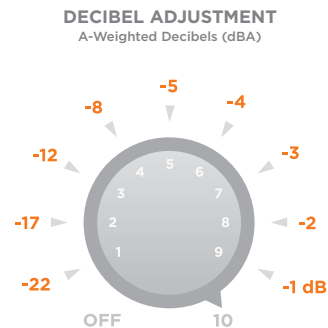

## Edit a property

### Create a property

See the 'Create the property' section in 'Custom tune your first room.'

### Edit a property file

1. Go to the Property screen.
2. Click the 'Open' button.
3. Navigate to the location where the property file is stored.
4. Select the file and click the 'Open' button.

**NOTE:** When you open a property file, MAESTRO displays the file name below the property name. To display the file path, mouse over the file name. MAESTRO also displays the property name at the bottom of all screens.

5. Click the 'Edit' button and modify the details as desired.

## Edit a room

### Use the room list

MAESTRO displays the rooms in a list, grouped by floor.

To display the list in ascending or descending order, click the Arrow button to the right of the Room heading.

To filter the list by room number and/or status, click the filter  icon at the top right-hand corner of the room list and enter the desired criteria into the search field or deselect the status (Custom Tuned, Profile or Pending Setup) you do not want to review. When MAESTRO applies the desired filter, it displays an X next to the icon. To clear all filters, click the X.

To expand or collapse a floor, click the Arrow button to the right of the 'Floor' heading. To expand or collapse all floors, click the  icon at the top right-hand corner of the room list.

To view the total number of rooms by status (Custom Tuned, Profile or Pending Setup), click the  icon at the bottom right-hand corner of the room list. MAESTRO displays the total number by floor next to the 'Floor' heading and the total number for the property next to the icon.

### Review room details

Click the  icon. The information MAESTRO displays on the Room Details window depends on the room's status. If the room is Pending Setup, MAESTRO shows the details you entered when you created the room. If the room is Custom Tuned or assigned a Profile, MAESTRO displays those details.

To navigate between rooms within the Room Detail window, click the Previous or Next buttons.

To display details about the MODIO device installed in the room such as the serial number, firmware version and settings, click the 'Device Info' button.

To review the results of custom tuning the room, click the 'Graph' button. MAESTRO displays a graph showing the room's background sound and masking sound measurements. The grey shaded area indicates the target masking spectrum and allowable tolerances within each frequency. To view the level at a particular frequency, mouse over the graph. By default, the graph shows the frequency range over which MODIO was tuned; to see the full measurement range, select the 'Full' option.

### Add a room

See the 'Add the room(s)' section in 'Custom tune your first room.'

### Edit a room

1. Go to the Rooms screen.
2. Select the desired room in the list.
3. Click the  icon.
4. Modify the desired element (e.g., floor, room number, notes).
5. Click the 'Save' button.

**NOTE:** If you make a change to the floor or room number and it already exists, MAESTRO disables the 'Save' button to prevent a duplicate entry.

### Remove a room

1. Go to the Rooms screen.
2. Select the desired room in the list.

**NOTE:** To select multiple rooms, either press and hold the 'Shift' key on your laptop as you select the first and last rooms (if they are sequential) or the 'Ctrl' key as you select the rooms (if they are non-sequential).

## Edit a room (continued)

3. Click the  icon. MAESTRO prompts you to confirm removal because, once completed, this operation cannot be reversed.

### Reset a room to factory defaults

**IMPORTANT:** This procedure permanently deletes all data for the selected room. You may wish to perform these steps if you are retuning MODIO in the room or moving the device to another room. However, in either case, resetting is an optional, not mandatory, step.

1. Go to the Rooms screen.
2. Select the desired room in the list.
3. Click the  icon. MAESTRO restores the factory defaults to MODIO and returns the room to pending status.

**NOTE:** You can also handle this procedure from the Setup screen. Click the Down Arrow button next to 'Device Details' and select 'Reset Device to Factory Settings.'

---

## Use a profile

Custom tuning of each room is preferred; however, there are times when it is not possible (e.g., due to persistent noise interfering with the process).

In these cases, you can create a Profile based on a custom tuned room, which includes volume and frequency settings you can apply to rooms of the same type. 'Types' are rooms of the same size, shape, finishings, furnishings, and MODIO install location. If a room differs in any way, it belongs to a different type. Properties typically have a limited number of types; for example, a hotel may offer guests a 'Standard Queen Room,' but you may need to establish different 'Standard Queen' profiles if some of these rooms differ from one another in any of the aforementioned ways.

### Create a Profile

See the 'Create a profile' section in 'Custom tune your first room.'

### Apply a Profile

**IMPORTANT:** Do not apply a Profile created for one type of room to another type because the masking sound will not be correct.

1. Go to the Rooms screen.
2. Select the desired room in the list.
3. To select the desired Profile, click the  icon. MAESTRO opens a list of previously created profiles.
4. Select the desired Profile in the list.
5. Click the 'OK' button.

### Review a Profile

Go to the Profiles screen, which displays the list of profiles for the current selected property. MAESTRO indicates whether the profiles are 'In Use' (applied to a device(s) at the property) and the source room (in the 'Based On' column). If you select a Profile, MAESTRO also displays its volume and equalizer (EQ) settings.

### Edit a Profile

1. Go to the Profiles screen.
2. Select the desired Profile in the list.
3. Click the 'Edit' or 'Delete' button, as desired.

**NOTE:** You cannot delete a Profile if it is 'In Use.'

## Generate a report

### Select the options

You can ask MAESTRO to:

- Indicate when it completes a report, display the report when complete, or open the folder in which it is saved.
- Include graphs that provide a summary of masking results, and/or a summary of the existing background sound. In this case, MAESTRO summarizes results for all rooms, by floor.
- Include a detail page for each room. Custom Tuned rooms include a graph and table of results before and after MODIO implementation. Rooms with Profiles include a graph and table of the Profile name and settings. You can also exclude rooms that are Pending Setup.
- Generate a title page and table of contents.
- Display particular elements on the title page. Note that the property section is based on the information entered on the Property screen. If desired, click the  icon to access the Technician screen where you can enter information about the in-house or third-party technician setting up the MODIO devices.
- Add a footer that you can toggle on and off, as needed.

### Generate a report

1. Go to the Reports screen.
2. Configure the report options (see above for details).
3. Click the checkbox(es) beside the room(s) you want to include.
4. Click the Report button.

## Take a measurement

You can use MAESTRO to measure existing background noise levels or noise coming from a particular source (e.g., HVAC or exterior traffic).

Alternatively, you can use this function to measure the guestroom masking level at different control pad settings; in this case, note that other noise can impact the measured level (increasingly so as you lower the masking level).

**IMPORTANT:** You MUST calibrate the sound meter prior to using it for measurement and tuning.

**NOTE:** MAESTRO Pro Kit required.

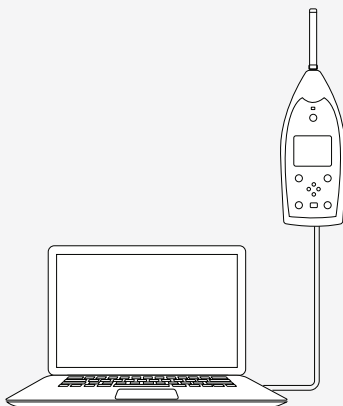

1. Connect the sound meter to the laptop (as shown above), and launch MAESTRO.
2. Go to the Rooms screen.
3. If you want to associate the measurement with a particular room, select the room you want to measure. If not, press and hold the CTRL key on your keyboard and click the currently selected room to deselect it.

## Take a measurement (continued)

4. Click the  icon. MAESTRO opens the Measurement window.  
**NOTE:** If the room features an already tuned MODIO, the graph MAESTRO displays will include a grey shaded area indicating the range within which the masking sound was adjusted.
5. Enter the number of seconds over which you want to measure.  
**NOTE:** The default is 15 seconds. The minimum is 1 second and the maximum is 99 seconds. The desired length depends on the type of test you plan to conduct:
  - If measuring a relatively consistent noise (e.g., ventilation, appliance), set the period between 15 and 30 seconds. Ensure the noise is present during the entire period. If it is not, MAESTRO will average its level with that of the relative quiet before/after the noise.
  - If measuring an intermittent or changing noise (e.g., train, plumbing), set the period between 1 and 5 seconds. Begin measuring while the noise is occurring. If the noise is unpredictable, it might be challenging to measure and require several attempts.
6. Enter any notes you want to associate with the measurement, to help you recall the details of the test (e.g., HVAC on high, measured bedside).
7. To begin measuring, click the 'Measure' button. MAESTRO indicates it is starting the measurement and begins counting down the seconds over which you intend to measure.  
**IMPORTANT:** Keep as silent as possible. Hold and move the sound meter as described in 'Custom tune your first room.'  
**IMPORTANT:** Take note of any noises that occurred while measuring, other than what you intended to measure. If interfering noise occurred, you might need to repeat the measurement.
8. MAESTRO displays the results in graph format.  
**NOTE:** The results are time-averaged over the measurement period. The graph shows the level of each one-third octave frequency. MAESTRO displays the overall level in the legend at the top right corner of the screen. To view the level at a particular frequency, mouse over the graph. If measuring in a room with a tuned MODIO, the graph shows the frequency range defaults to that over which MODIO was tuned; to see the full measurement range, select the 'Full' option.
9. To save the results, click the 'Copy Values' button. Windows copies the data to the Clipboard. You can then paste it into a spreadsheet (e.g., Excel) and save that file. If you want to copy the graph, click the 'Copy Graph' button, paste it into a document (e.g., Word, PowerPoint), and save that file.  
**IMPORTANT:** MAESTRO will not store the measurement results.
10. To take another measurement, click the 'New Measure' button. MAESTRO prompts you to confirm that you would like to proceed (and overwrite the last measurement).

## Educate guests

### Add MODIO to the guest directory

If you would like to include information about MODIO in your guest directory, the MODIO manufacturer suggests the following:

#### MODIO® Guestroom Acoustic Control

We prioritize your wellness and want you to have a relaxing stay and good night's sleep.

MODIO introduces a continuous soothing background sound into your room, allowing you to control its acoustic ambience as you would temperature and lighting. The sound is similar to soft airflow, designed for comfort, and specifically engineered to cover a wide variety of noises.

Unlike 'white noise' machines or apps, MODIO is a commercial-grade device designed by the manufacturer of the LogiSon® Acoustic Network—a company with over 45 years' experience in the sound masking field. Their award-winning products have been installed in hundreds of millions of square feet worldwide, including offices, banks, call centers, hospitals, and more.

MODIO is mounted [location] in order to disperse the masking sound within the area of your bed. To adjust the level, simply turn the dial on the control pad to a position between 'OFF' and '10.'

#### Provide guest instructions

A label applied to the bottom of the control pad quickly tells guests about the purpose and use of this amenity. It reads: MODIO introduces a continuous soothing background sound into your room, allowing you to control its acoustic ambience as you would temperature and lighting. To set the volume to your desired level, simply turn the dial to a position between 'OFF' and '10.'

The MODIO manufacturer also offers a guest instruction card, which you can print and place beside the control pad. It is available for download in various formats from [www.modio.audio](http://www.modio.audio). You can print additional copies as needed or use the text provided to produce your own cards featuring your property's branding.

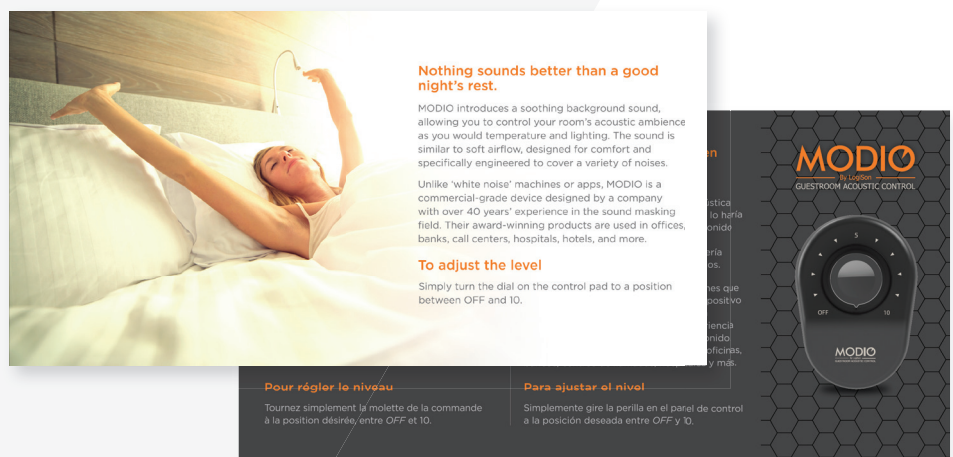

**Nothing sounds better than a good night's rest.**

MODIO introduces a soothing background sound, allowing you to control your room's acoustic ambience as you would temperature and lighting. The sound is similar to soft airflow, designed for comfort and specifically engineered to cover a variety of noises.

Unlike 'white noise' machines or apps, MODIO is a commercial-grade device designed by a company with over 40 years' experience in the sound masking field. Their award-winning products are used in offices, banks, call centers, hospitals, hotels, and more.

**To adjust the level**

Simply turn the dial on the control pad to a position between OFF and 10.

**Pour régler le niveau**

Tournez simplement la molette de la commande à la position désirée, entre OFF et 10.

**Para ajustar el nivel**

Simplemente gire la perilla en el panel de control a la posición deseada entre OFF y 10.

**MODIO**  
LogiSon®  
GUESTROOM ACOUSTIC CONTROL

MODIO

## Educate staff

### Restore the default level

MODIO is an important part of achieving your property's acoustical goals. The best way to introduce its benefits is to ensure the technology is on and set to the default level before the guest arrives in their room. Leaving MODIO 'OFF' is not recommended, because it means the guest will only activate the technology after being made aware of—and likely bothered by—noise. In other words, MODIO is best positioned as a proactive solution, rather than a reactive one.

During their stay, the guest will likely adjust the level according to their personal preference or need. After they depart, housekeeping staff should restore MODIO to the default level. To do so, they simply need to turn the dial so the arrow aligns with the default setting (between 1 and 10) you established.

### Learn the basics

Noise is one of the main obstacles to focus, relaxation and sleep, affecting guests' wellbeing and overall experience at a property. To help build brand value, acknowledge MODIO as a room enhancement and let staff know how to talk about it.

The core messages to share are:

- MODIO is a new room amenity that helps provide a more restful and relaxing environment.
- MODIO uses a sound similar to softly blowing air to cover, or mask, noises.
- MODIO is adjustable to the guest's own comfort level. It basically allows them to control their room's acoustical conditions as they would its temperature and lighting.

When receiving in-person or online feedback, it is important to note that while guests appreciate what MODIO does, they rarely call it by its proper name: sound masking. Instead, they will often use descriptors such as 'white noise,' 'noise cancellation,' 'sound machine,' and so on.

Let housekeeping know the default level to which they should set MODIO in preparation for a new guest's arrival. Also let housekeeping staff know about the guest instruction card, so they do not accidentally remove it from the room.

For the same reason, ensure maintenance staff are aware of both MODIO and its control pad.

### Take it to the next level

If staff are interested in learning more about how sound masking works, share the following:

Guest rooms often have very low background sound levels of only 28 to 32 decibels, like libraries. In these 'pin-drop' environments, occupants are easily disturbed by all kind of noises. Although adding more sound might seem to contradict the goal of improving acoustics, guests can be made more comfortable by increasing the background sound level in a controlled way using a commercial-grade sound masking technology.

Sound masking does not absorb, block or cancel noise. Rather, it works by interfering with our ears' ability to perceive other sounds. This ability—of sound to cover another sound—is an effect we often experience (due to running water, rustling leaves or the murmur of a crowd, for example), but rarely think about in the context of the indoor environment. Yet, when handled correctly, a subtle background sound not only minimizes the disruptive impact of noise, but does so comfortably. Of course, in order for this technology to work, you have to

## Educate staff (continued)

be able to hear the masking sound, but it is designed to be as unnoticeable as possible. Most compare it to soft airflow.

In comparison to 'white noise' machines and apps, MODIO provides a fuller, more comfortable and more effective masking sound. It is highly effective against many common hotel noises, whether they come from inside or outside the property. That said, masking is not magic. The degree to which various noises are covered depends on both the masking sound level and that of the noise itself, as well as the type of space treated. Even if the masking sound does not completely cover a noise, it will reduce its disruptive effect by minimizing the amount of change guests experience within the treated area.

### **Talk like a pro**

Impress everyone by learning key terms relating to guestroom acoustics:

**Acoustics** – The science of the production, control, transmission, reception, and effects of sound.

**Sound** – Something that is heard.

**Noise** – Unwanted sound. Not all sound (e.g., music you want to hear) is noise.

**Silence** – The absence of sound.

**Quiet** – The absence of noise, which is the goal in guest rooms. The quiet in a silent space can easily be interrupted by any noise. In contrast, a quiet space need not be silent (e.g., if a comfortable masking sound prevents you from being disrupted by noise).

**Sound Masking or Masking** – The effect of reducing or eliminating your ability to hear a noise due to the presence of a masking sound. By covering noises with a masking sound, MODIO makes guest rooms quieter.

**Sound Level** – The measure of the volume of an overall sound (across all measured frequencies) or specific frequency bands (ranges).

**Loudness** – The subjective perception of sound level.

**Decibel (dB)** – The unit of measure for sound level. The scale is logarithmic, so small changes in value indicate large changes in volume (e.g., a 3dB increase is twice the sound energy and a 10dB increase is perceived as twice as loud).

**A-Weighted Decibel (dBA)** – The measure of level that approximates how the human ear perceives sound. It de-emphasizes the high and low frequencies, to which we are less sensitive.

**Dynamic Range** – The difference between the highest and lowest sound levels over a period of time. By establishing a higher background sound level, MODIO reduces the amount of dynamic range guests experience in the room.

**Frequency** – The number of sound waves per second. Low frequency sounds are low pitch (e.g., bass in music). Higher frequency sounds are higher pitch (e.g., crickets chirping).

**Hertz (Hz)** – The unit of measure for frequency.

**Frequency Band** – A range of sound frequencies, identified by its middle frequency. MODIO is adjusted in one-third octave bands (each octave divided into three segments).

## Educate staff (continued)

**Equalizer** – An audio system function that adjusts the level of individual frequency bands.

**White Noise** – A broadband sound with levels increasing as frequency increases, perceived as ‘hissy’ (like static on an old TV). Masking sound is often incorrectly referred to as “white noise.”

**Pink Noise** – A broadband sound with constant frequency levels, perceived as ‘rumbly’ (like a waterfall).

**Spectrum** – The composition of a sound, expressed in frequency and level. In masking applications, it is also called a “curve.”

**Masking Spectrum** – A specific sound (not white or pink noise) with frequencies balanced for comfort and effectiveness. Level decreases as frequency increases.

**Sound Meter** – A device used to measure sound levels. Sometimes referred to as an analyzer.

**Calibrator** – A device used to ensure the sound meter accurately measures sound.

**Tuning** – The process of adjusting the measured masking sound to the target spectrum and level, within specified tolerances.

---

## Get help

### MODIO

If MODIO is not making any sound, take the following steps in sequence:

1. Ensure the control pad is connected.
2. Ensure the control pad dial is not set to ‘OFF.’
3. Check the power supply connection at the device and electrical outlet.
4. Ensure the electrical outlet has power (i.e., check if other devices connected to it have power).
5. Try another MODIO power supply.
6. Contact the manufacturer by emailing [techsupport@modio.audio](mailto:techsupport@modio.audio). Support is available from 9:00 AM to 5:00 PM (Eastern Time) on weekdays.

### Control pad

If the control pad is not working correctly (e.g., it will not turn ‘OFF’), perform the procedure outlined in the ‘Calibrate the control pad’ section of this manual.

### MAESTRO

MAESTRO provides a Help screen that allows you to access the user guide directly within the software.

The software also offers automated troubleshooting in the form of a status bar at the bottom of the Setup and Room screens. If you have not connected an item correctly or MAESTRO is unable to communicate with it, MAESTRO displays a red X next to it within the status bar and offers a ‘Help’ link you can click to begin the troubleshooting process. Simply follow the onscreen steps.

If you resolve the issue, MAESTRO replaces the X with a green checkmark after a few seconds.

## Get help (continued)

### Tech support

If you cannot resolve the issue, contact the manufacturer by emailing [techsupport@modio.audio](mailto:techsupport@modio.audio). Support is available from 9:00 AM to 5:00 PM (Eastern Time) on weekdays.

Depending on the type of issue, MODIO Tech Support might ask you to go to the Setup screen and:

- Click the 'Properties' button to provide sound meter details.
- Check the 'Device Details' section on the Setup screen to provide information such as the serial number, firmware version and settings for the currently connected MODIO, as well as its room assignment (if applicable).
- Click the Down Arrow button in the 'Device Details' section of the Setup screen and select 'Copy' from the list in order to paste MODIO settings into a document or email.

## Maintenance

**IMPORTANT:** Before you connect or disconnect any components, always disconnect the power supply.

The manufacturer strongly recommends maintaining a small inventory of extra components—including MODIO, control pads and power supplies—in order to efficiently provide service to guests. You can also order replacement parts from your MODIO supplier.

**NOTE:** Bolts meeting the MODIO specs can be sourced from a hardware supplier.

**Optional bracket  
or plate kit**

**Mount under or behind a furnishing**

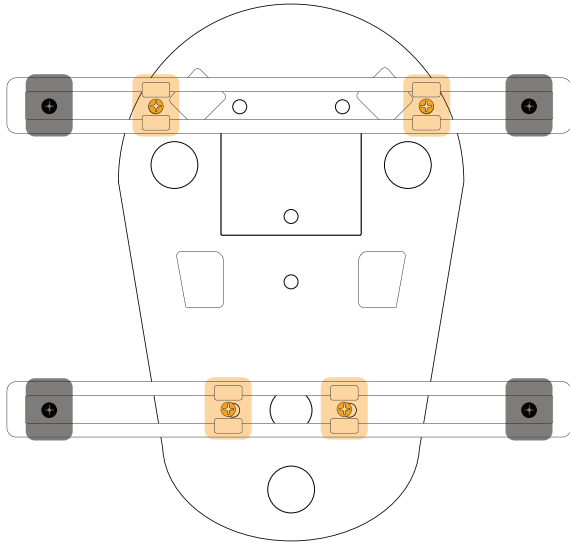

**Using Two Brackets**  
Wide Configuration

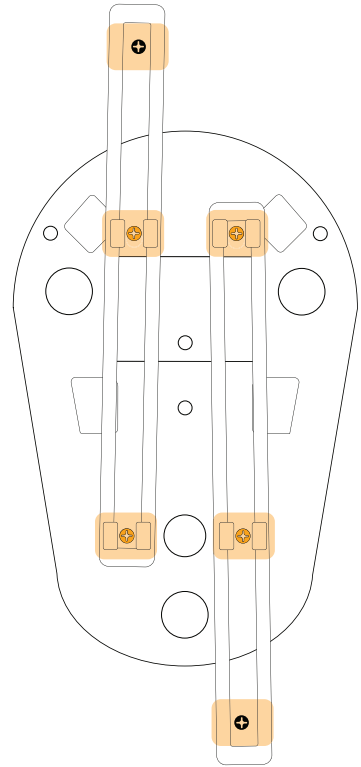

**Using Two Brackets**  
Narrow Configuration

1. Determine the required mounting configuration (see diagrams above).
2. Place MODIO grill side down on a soft surface.
3. Place the brackets on the back of MODIO, per the diagram.

**NOTE:** The washers and bolts shown in orange are supplied with the bracket kit, whereas the washers, bolts and/or screws shown in black will vary depending on site conditions and, therefore, are not.

**NOTE:** The 'Wide Configuration' does not show the two remaining supplied washers, so that the four used to attach the bracket to the furnishing match.

4. Insert four washers into the slot within the bracket (as shown).
5. Insert four bolts into the washers.
6. Tighten the bolts using a Phillips screwdriver.
7. Using appropriately-sized screws and washers, attach MODIO to the desired furnishing.

**Optional bracket  
or plate kit  
(continued)**

**Mount to back of television**

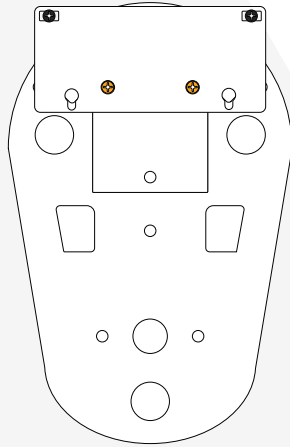

**Using the Plate**  
100 mm VESA Configuration

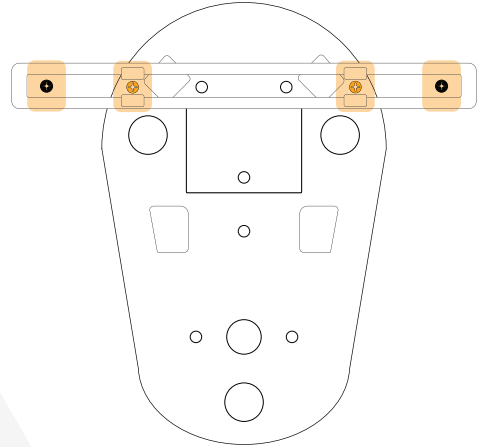

**Using One Bracket**  
200 mm VESA Configuration

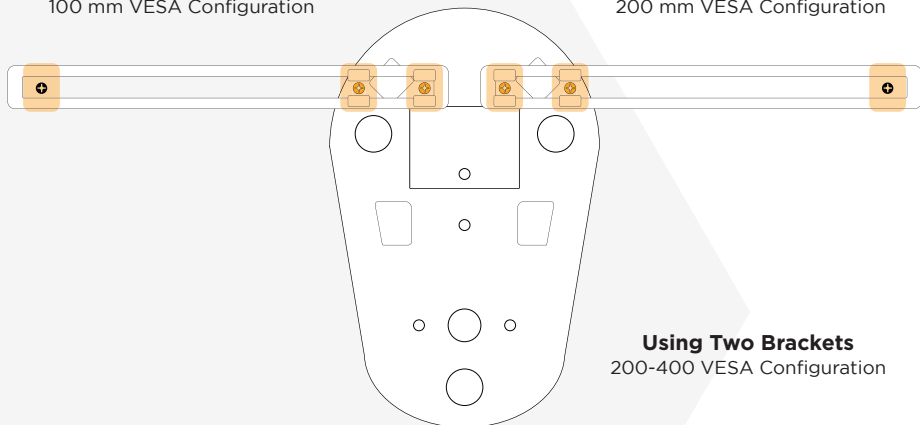

**Using Two Brackets**  
200-400 mm VESA Configuration

1. Determine the required mounting configuration (see diagrams above).
2. Place MODIO grill side down on a soft surface.
3. Place the plate/bracket(s) on the back of MODIO, per the diagram.

**NOTE:** The washers and bolts shown in orange are supplied with the plate/bracket kit, whereas the washers, bolts and/or screws shown in black will vary depending on site conditions and, therefore, are not.

**NOTE:** If using the plate, ensure the recessed mounting holes are facing you and aligned with the small circular holes on the back of MODIO (as shown). Insert the two bolts.

**NOTE:** If using the bracket(s), insert the required number of washers (as shown) into the slot within the bracket, and then insert the required number of bolts into the washers.

4. Tighten the bolts using a Phillips screwdriver.
5. Align the plate/bracket(s) with the television's VESA mounts.
6. Using appropriately-sized bolts and washers, attach MODIO to the television.

**NOTE:** Depending on the required bolt size, you may need different washers than those supplied in the kit.

**Optional bracket  
or plate kit  
(continued)**

**Mount to wall**

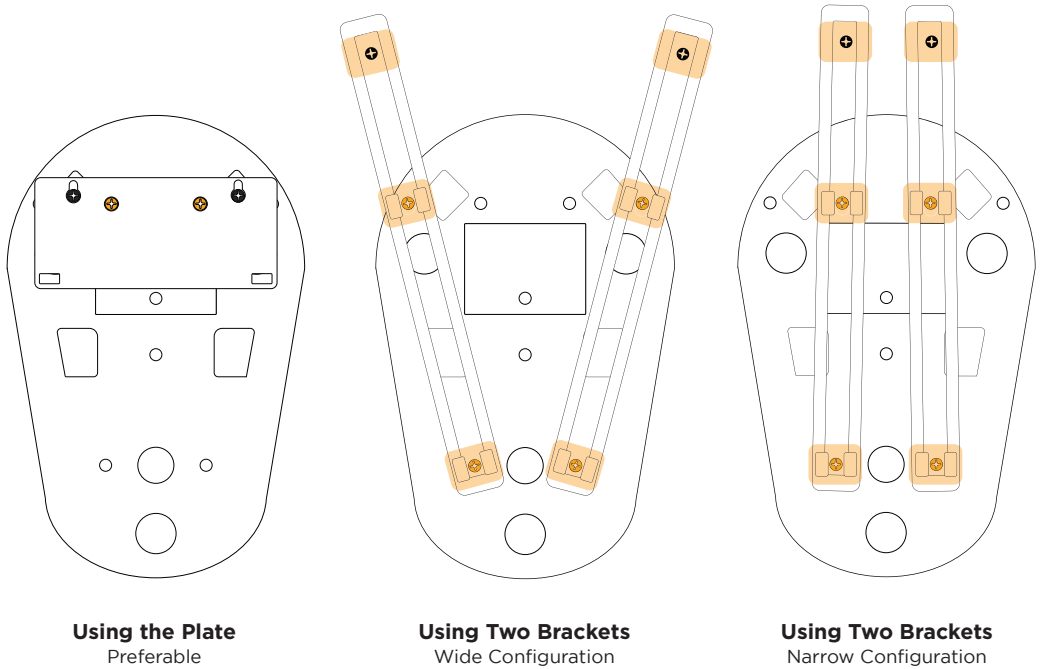

1. Determine the required mounting configuration (see diagrams above).
2. Using the plate/brackets as a template(s), mark the screw locations on the wall.
3. Place MODIO grill side down on a soft surface.
4. Place the plate/brackets on the back of MODIO, per the diagram.

**NOTE:** The washers and bolts shown in orange are supplied in the plate/bracket kit, whereas the washers, bolts and/or screws shown in black will vary depending on site conditions and, therefore, are not.

**NOTE:** If using the plate, ensure the recessed mounting holes are facing you and aligned with the small circular holes on the back of MODIO (as shown). Insert the two bolts.

**NOTE:** If using the bracket(s), insert four washers (as shown) into the slot within the bracket, and then insert four bolts into the washers.

5. Tighten the bolts using a Phillips screwdriver.
6. Using appropriately-sized wall anchors and screws, attach MODIO to the wall.

## MAESTRO End-User License Agreement

**IMPORTANT:** This End-User License Agreement (“EULA”) is a legal agreement between you (either an individual or a single entity) and K.R. Moeller Associates Ltd. (“Moeller”) for the Moeller software product identified in this section of the user guide, which includes computer software and may include associated media, printed materials, and online or electronic documentation (“Software Product”). The Software Product also includes any updates and supplements to the original Software Product provided to you by Moeller.

By installing the Software Product, you agree to be bound by the terms of this EULA. If you do not agree to the terms of this EULA, do not install or use the Software Product.

Your license rights under this EULA are non-exclusive. Moeller retains all rights, title and interest, including all copyright and intellectual property rights, in and to, the Software Product (including but not limited to any images, photographs, animations, video, audio, music, and text) and all copies thereof. You may not redistribute, sell, rent, lease, sublicense, alter, merge, modify, adapt, translate, decompile, reverse engineer, disassemble, or otherwise reduce the Software Product to a human-perceivable form or create any derivative works based upon the Software Product. All rights not specifically granted in this EULA are reserved by Moeller. Certain rights are not granted under this Agreement, but may be available under separate agreement.

The Software Product is provided to you free of charge, on an “as-is” basis. Moeller provides no warranties for the Software Product. To the maximum extent permitted by applicable law, in no event shall Moeller be liable for any damages whatsoever arising out of the use of or inability to use the Software Product.

You agree that Moeller may audit your use of the Software Product for compliance with these terms at any time, upon reasonable notice. Without prejudice to any other rights, Moeller may terminate this EULA if you fail to comply with the terms and conditions of this EULA. In such event, you must destroy all copies of the Software Product and all of its component parts.

This EULA is governed by the laws of the Province of Ontario, Canada.

## Warranty

**IMPORTANT:** BY USING THE *MODIO® GUESTROOM ACOUSTIC CONTROL* PRODUCT, YOU ARE AGREEING TO BE BOUND BY THE TERMS OF THIS LIMITED WARRANTY (“**WARRANTY**”) AS SET OUT BELOW.

DO NOT USE THE *MODIO® GUESTROOM ACOUSTIC CONTROL* PRODUCT UNTIL YOU HAVE READ THE TERMS OF THIS WARRANTY. IF YOU DO NOT AGREE TO THE TERMS OF THIS WARRANTY, DO NOT USE THE PRODUCT AND CONTACT THE AUTHORIZED RESELLER FROM WHICH THE *MODIO® GUESTROOM ACOUSTIC CONTROL* PRODUCT WAS PURCHASED TO ARRANGE FOR A RETURN WITHIN THE APPLICABLE RETURN PERIOD.

### **What is covered by this Warranty?**

Subject to the terms of this Warranty, we, K. R. MOELLER ASSOCIATES LTD. of 3-1050 Pachino Court, Burlington, Ontario L7L 6B9 Canada, warrant that the components of the *MODIO® Guestroom Acoustic Control* product (the “**MODIO® Product**”) is free from defects in materials and workmanship when used normally for a period of: (a) one (1) year from the original date of purchase for the control pad and power supply included with the *MODIO® Product*; and (b) five (5) years from the original date of purchase for any components of the *MODIO® Product* (the “**Warranty Period**”).

This Warranty is only for the model of the *MODIO® Product* that operates with a control pad, and specifically excludes any model of *MODIO®* that has an integrated dial controller, including the *MODIO® Home Edition* product and any other model of *MODIO®*. In addition, this Warranty is only for the *MODIO® Product* itself and any issues regarding testing, installation or maintenance services should be directed to the authorized reseller or other person who performed these services.

### **What is not covered by this Warranty?**

This Warranty does not apply to any products, systems, components or accessories, that do not form part of the *MODIO® Product*, or were manufactured by other companies. Other manufacturers, suppliers, or sellers, other than us, may provide their own warranties to you for these excluded products systems, components or accessories, and you should contact them for further information about their warranties. We do not warrant that the operation of the *MODIO® Product* will be uninterrupted or error-free. We are not responsible for damage arising from failure to follow instructions relating to the proper use of the *MODIO® Product*.

This Warranty does not apply to: (a) consumable parts, such as protective coatings that are designed to diminish over time, unless failure has occurred due to a defect in materials or workmanship; (b) cosmetic damage, including but not limited to scratches, dents and broken plastic on ports; (c) defects or damage caused by unauthorized use with a third party component, accessory or ancillary/peripheral product not furnished or approved by us; (d) defects or damage caused by accident, abuse, misuse, abnormal conditions, exposure to liquid, moisture, dampness, sand or dirt, neglect, or unusual physical, electrical or electromechanical stress, fire, earthquake or other external causes; (e) defects or damage caused by improper testing, operation, maintenance, installation, service or adjustment; (f) damage to any *MODIO® Product* that has been modified to alter functionality or capability without our written permission; (g) normal wear and tear or otherwise due to the normal aging of the *MODIO® Product*; (h) any *MODIO® Product* that may have its product label removed, defaced, damaged, altered or made illegible; (i) defects or damage to any *MODIO® Product* for which we have received information from a relevant public authority that the product has been stolen; or (j) damage to any *MODIO® Product* that has been resold, transferred or assigned by the original purchaser or otherwise purchased from a person that is not our authorized reseller.

## Warranty (continued)

### How to obtain warranty service?

If the *MODIO*® Product is not functioning properly, please contact the party from which the *MODIO*® Product was purchased. Either we or the authorized reseller, as the case may be, will help determine whether your *MODIO*® Product requires warranty service and, if it does, either we or the authorized reseller, as the case may be, will inform you how service will be provided. When contacting us or the authorized reseller by telephone, other charges may apply depending on your location. If the warranty service for the *MODIO*® Product requires you to return it to us or the authorized reseller, any applicable shipping and handling charges shall be your responsibility.

We reserve the right to require you to furnish proof of purchase details including a copy of any invoice by which you acquired the *MODIO*® Product, and for you to respond to questions designed to assist with diagnosing potential issues and to follow our procedures for obtaining warranty service.

If determined that the *MODIO*® Product is not covered by the Warranty, you must pay for all parts, and any labour and service charges for the inspection and repair of the *MODIO*® Product.

If it is determined that your *MODIO*® Product requires warranty service, our authorized reseller may be required to remove and forward the *MODIO*® Product from your location to our location to perform repair services.

We reserve the right to change the method by which we may provide warranty service to you and your *MODIO*® Product's eligibility to receive a particular method of service.

### Warranty Claim

If during the Warranty Period you submit a warranty service claim to us in accordance with this Warranty, we will, at our sole option:

- a) repair the *MODIO*® Product using new or previously used, rebuilt or reconditioned parts or components that are equivalent in performance and reliability; or
- b) replace the *MODIO*® Product with the same model (or a product that has similar functionality) formed from new and/or previously used, rebuilt or reconditioned parts that are equivalent in performance and reliability.

A replacement part or *MODIO*® Product assumes the remaining term of the Warranty or ninety (90) days from the date of replacement or repair, whichever is longer. When a *MODIO*® Product or part is replaced, any replacement item becomes your property and the replaced item becomes our property.

### Limitation of Liability

All implied warranties, including without limitation, implied warranties of merchantability and fitness for a particular purpose, are limited to the duration of this Warranty. In no event shall we, or our authorized resellers, be liable for damages in excess of the purchase price paid for the *MODIO*® Product, or for, without limitation, and except as provided in this Warranty and to the maximum extent permitted by law, direct, special, incidental, or consequential damages resulting from any breach of warranty or condition, or under any other legal theory, including but not limited to loss of use; loss of revenue; loss of actual or anticipated profits (including loss of profits on contracts); loss of the use of money; loss of anticipated savings; loss of business; loss of opportunity; loss of goodwill; loss of reputation; loss of, damage to, compromise or corruption of data; or any indirect or consequential loss or damage howsoever caused including the replacement of equipment and property.

## Warranty (continued)

The foregoing limitation shall not apply to death or personal injury claims, or any statutory liability for intentional and gross negligent acts and/or omissions. We disclaim any representation that we will be able to repair any *MODIO*® Product under this Warranty. Some provinces, states and jurisdictions do not allow limitations on how long an implied warranty lasts, or the disclaimer or limitation of incidental or consequential damages, so the above limitations and disclaimers may not apply to you. Residents of Quebec are governed by that province's consumer protection legislation.

We make no warranties or representations, express or implied, statutory or otherwise, as to the quality, capabilities, operations, performance or suitability of any third-party software or equipment used in conjunction with the *MODIO*® Product, or the ability to integrate any such software or equipment with the product. Responsibility for the quality, capabilities, operations, performance and suitability of any such third-party software or equipment rests solely with you and the direct vendor, owner or supplier of such third-party software or equipment.

This Warranty gives you specific legal rights, and you may also have other rights that vary from jurisdiction to jurisdiction.

### **Severability**

If any portion of this Warranty is held to be illegal or unenforceable, such partial illegality or unenforceability shall not affect the enforceability of the remainder of the Warranty.

### **General**

Nothing contained in any other document relating to the *MODIO*® Product shall be construed to create an express warranty of any kind with respect to the *MODIO*® Product. No *MODIO*® Product reseller, distributor, agent, dealer, or employee is authorized to make any modification, extension, or addition to this Warranty, unless authorized by us in writing. This Warranty shall be governed by and construed in accordance with the laws of the Province of Ontario, unless prohibited by law, in which case this Warranty will be governed by and construed under the laws of the province, state, district, county or jurisdiction in which the *MODIO*® Product purchase took place. We or our successor in title are the warrantor under this Warranty.

## Tech specs

### MODIO **Masking Performance**

|                  |   |
|------------------|---|
| Sound Generation | Digital Signal Processor (DSP), truly random (nondeterministic) |
| Volume           | Up to 85 dBA @ 1 m (3.3 ft)                                     |
| Equalization     | 1/3-octave, 23 bands, 63 to 10,000 Hz                           |

### Connections

|                     |                           |
|---------------------|---------------------------|
| Power/Network Input | 6-pin                     |
| Control Input       | 3.5 mm 4-pole stereo jack |

### Power

|             |                           |
|-------------|---------------------------|
| Input       | 24 VDC                    |
| Consumption | 3.4 W at typical settings |

### Physical Specifications

|                        |   |
|------------------------|---|
| Dimensions (W x H x D) | 148 x 232 x 88 mm (5.8 x 9.1 x 3.5 inches)                        |
| Weight                 | 2.3 lbs (1 kg)  |
| Mounting               | Flexible mounting options; see pages 24-26                        |
| Certifications         | Meets UL, CE, ACMA (C-Tick), KC and FCC standards; RoHS compliant |
| Warranty               | 5 years   |

### CONTROL PAD

|                        |  |
|------------------------|--|
| Volume Range           | 22 decibels (plus 'OFF')                 |
| Dimensions (W x H x D) | 66 x 52 x 95 mm (2.6 x 2.0 x 3.7 inches) |
| Weight                 | 0.26 lbs (116 g)                         |
| Connection             | 3.5 mm 4-pole stereo plug                |
| Warranty               | 1 year                                   |

### POWER SUPPLY (MODEL SWI18-24-N)

### Electrical Performance

|                    |                         |
|--------------------|-------------------------|
| Input Voltage      | Min 90 VAC; Max 264 VAC |
| Input Frequency    | Min 47 Hz; Max 63 Hz    |
| Output Voltage     | 24 VDC                  |
| Output Power Range | Max 18 W                |

### Connections

|                       |   |
|-----------------------|---|
| Output Connector      | Barrel plug, 2.1 mm I.D. x 5.5 mm O.D. x 9.5 mm |
| Input Connector       | NEMA 1-15P                                      |
| Operating Temperature | 0°C - 40°C                                      |

### Physical Specifications

|                        |  |
|------------------------|--|
| Dimensions (W x H x D) | 72 x 34 x 52 mm (2.8 x 1.3 x 2.0 inches) |
| Weight                 | 0.375 lbs (170.1 g)                      |
| Cord Length            | 1.5 m (59 inches)                        |

### Certifications

|                   |   |
|-------------------|---|
| Safety Standards  | UL/cUL 60950-1, 62368-1; PSE  |
| EMC               | FCC Part 15B Class B  |
| RoHS              | RoHS compliant  |
| Energy Efficiency | DoE Level VI, CEC, ErP Stage 2  |
| Countries         | USA, Canada, Mexico, and Japan, as well as other countries accepting these certifications and NEMA 1-15P. |
| Warranty          | 1 year  |

## Tech specs (continued)

**POWER SUPPLY**  
(MODEL GST25A24)  
\* POWER CORD  
NOT INCLUDED

### Electrical Performance

|                    |                         |
|--------------------|-------------------------|
| Input Voltage      | Min 85 VAC; Max 264 VAC |
| Input Frequency    | Min 47 Hz; Max 63 Hz    |
| Output Voltage     | 24 VDC                  |
| Output Power Range | Max 25 W                |

### Connections

|                       |  |
|-----------------------|--|
| Output Connector      | Barrel plug, 2.1 mm I.D. x 5.5 mm O.D. x 11 mm |
| Input Connector       | IEC320-C14 AC Inlet                            |
| Operating Temperature | -30°C - 70°C                                   |

### Physical Specifications

|            |  |
|------------|--|
| Dimensions | 54 x 36 x 93 mm (2.1 x 1.4 x 3.7 inches) |
| Weight     | 0.48 lbs (219 g)                         |

### Certifications

|                   |   |
|-------------------|---|
| Safety Standards  | UL60950-1, CSA C22.2, TUV EN60950-1, BSMI CNS14336, CCC GB4943, PSE J60950-1, AS/NZS 60950.1, BIS IS13252, KC K60950-1, EAC TP TC 004 approved; SIRIM MS IEC60950-1 (optional) approved |
| EMC               | Compliance to EN55032(CISPR32) class B, EN61000-3-2,3, FCC PART 15 / CISPR22 class B, CAN ICES-3(B)/NMB-3(B), CNS13438 class B, GB9254, GB17625.1, EAC TP TC 020, MSIP KN32             |
| RoHS              | RoHS compliant  |
| Energy Efficiency | Level VI  |
| Countries         | For use in Europe, India, China, Australia, New Zealand, Russia, and more; request a complete list from the MODIO manufacturer.   |
| Warranty          | 1 year  |

**NOTE:** Technical specifications are subject to change without notice.

## Mechanical drawings

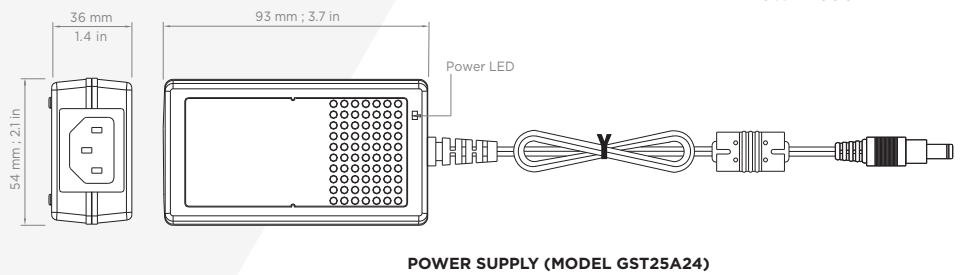
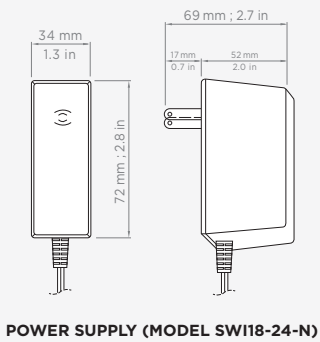
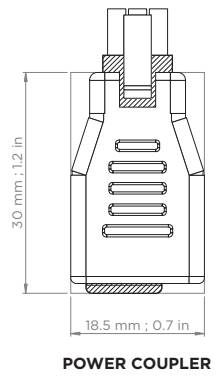
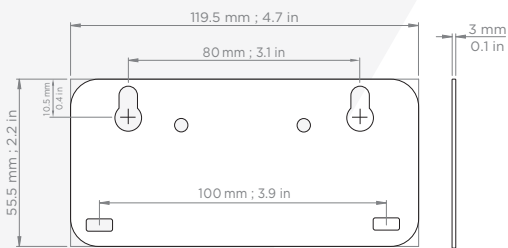
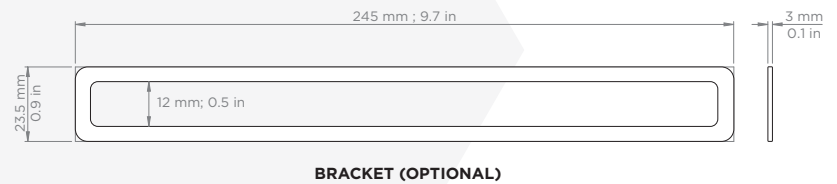
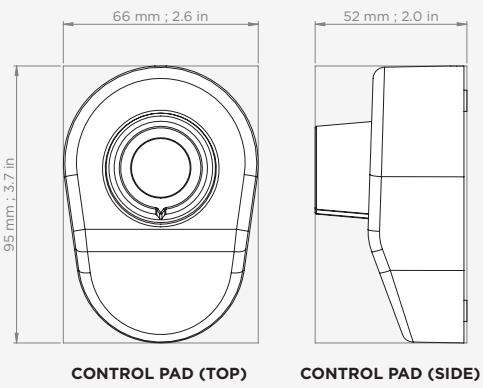
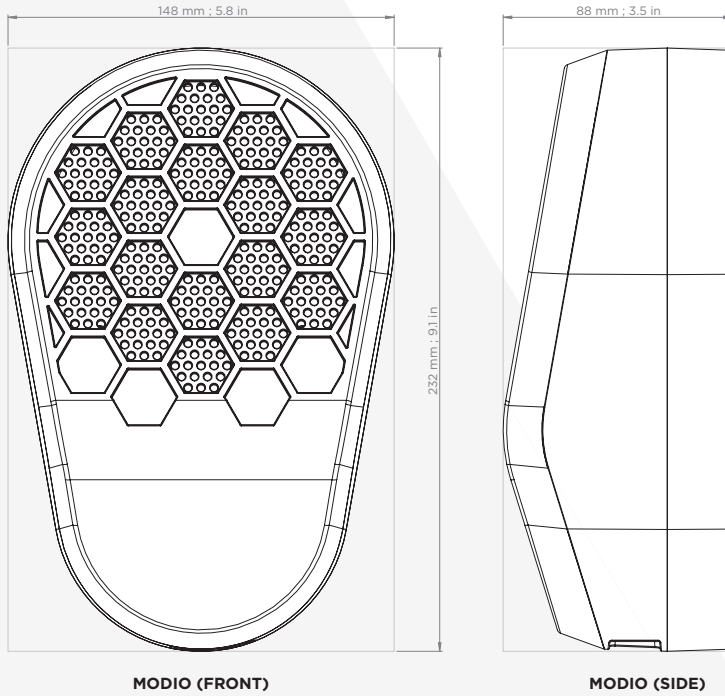

**NOTE:** Components are not shown to scale.





[www.modio.audio](http://www.modio.audio)

© 2026 K.R. Moeller Associates Ltd. Patent information at [modio.audio/patents](http://modio.audio/patents).  
MODIO and LOGISON are trademarks of 777388 Ontario Limited